

Product Information

Sensors and Instrumentation

Magnetic-Inductive Flow Probe FIS

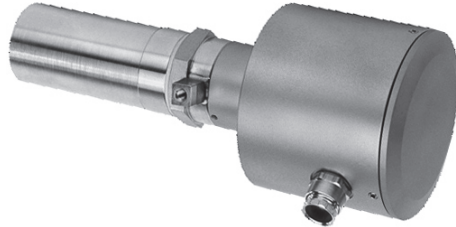

- Measurement of flow in conductive fluids
- A measurement probe for a wide range of piping diameters
- High quality materials
- No moving parts
- Change the sensor without loss of media

Characteristics

The FIS magnetic-inductive flow probes are built into the piping by means of the supplied welded-on sleeves (DN 50..DN 400) or by means of the plastic fixing clip (DN 50..DN 150) . The complete measurement probe is removable without creating an opening to the medium, and so if a fault occurs, only the electronic part is replaced.

When an electric conductor moves at right angles to the magnetic field, the movement induces a voltage U in the conductor. With this measurement principle, the electrically conductive medium is the conductor. The magnetic field B is transverse to the direction of flow. The induced voltage U is directly proportional to the local flow speed v.

Technical data

Sensor	magnetic-inductive
Nominal width	DN 50..300 welded-on nozzle DN 50..150 tapping sleeve
Process connection	welded-on nozzle, tapping sleeve
Metering ranges	full scales 1..8 m/s in steps of 1 m/s
Measurement accuracy	±5 % of the measured value, (when calibrated on the spot ±2 % of the measured value), from 3 cm/s
Repeatability	±2 % of the measured value
Time constant	5 seconds fixed
Media	conductive, largely homogeneous fluids, pastes, and slurries, also having solids components
Electrical conductivity	min. 20 mS/cm
Medium temperature	-25..+150 °C
Ambient temperature	-25..+60 °C
Operating pressure	max. 25 bar for welded-on nozzle max. 10 bar for tapping sleeve

Materials	Probe	stainless steel 1.4435
	Insulation	ceramic (zirconium oxide)
	Tapping sleeve	PP, 1.4305
	Electronics housing	stainless steel 1.4305 FKM and Klingerit
Supply voltage	24 V DC ±10 %	
Current consumption	50 mA (at 24 V DC and 20 °C)	
Output	4..20 mA (passive current output) load resistance max. 500 Ohm	
Ingress protection	IP 65 cable screw gland IP 67 round plug connector	
Weight	2,4 kg excluding tapping sleeve	
Conformity	CE	

Wiring

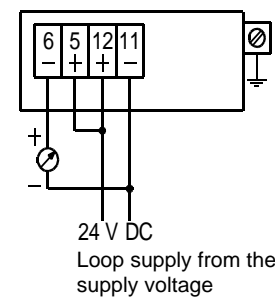
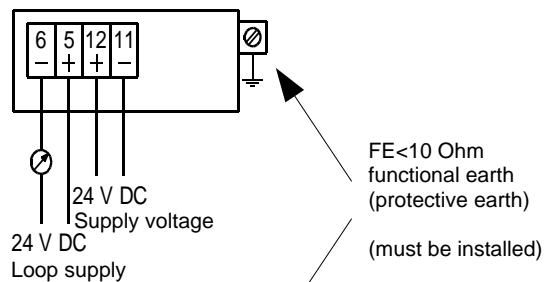

For model with round plug connector:

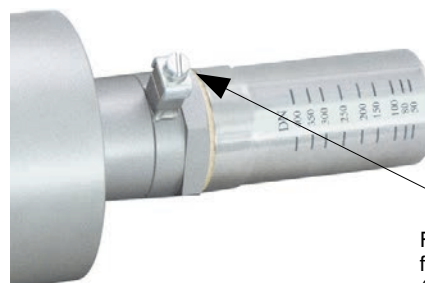
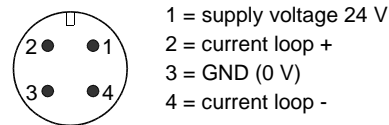

FE < 10 Ohm
functional earth
(protective earth)

(must be installed!)

Product Information

Sensors and Instrumentation

Dimensions

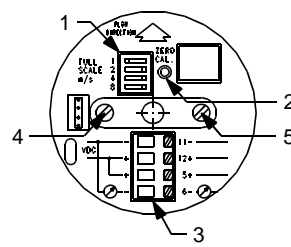
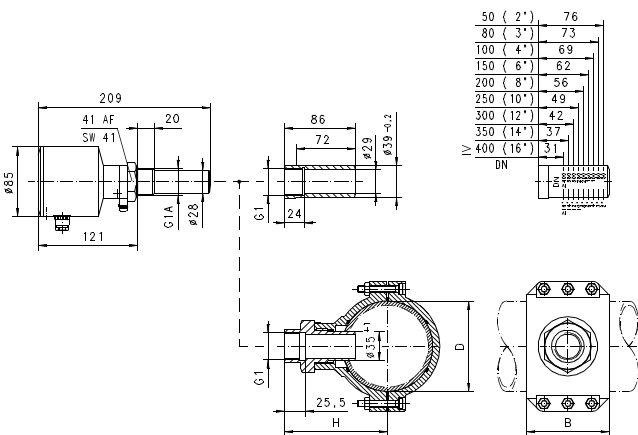

- 1 DIP switches
- 2 Button for zero point calibration
- 3 Connection clip

Example of the DIP switches

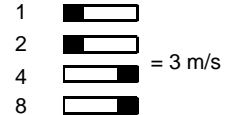

Zero point setting:

- Fill the piping completely with medium
- Flow speed in the piping must be "zero"
- Press the "ZERO CAL" button
- After one minute, the device has automatically self-calibrated

During commissioning, an automatic self-test is carried out. The device status is signalled at the current output:

- 3 mA The device is still conducting the self-test or has detected an error
- 4..20 mA Device is in measurement mode and is displaying the speed measured currently

Handling and operation

Installation

The FIS magnetic-inductive probes are installed in the pipework by means of the supplied welded-on sleeves or by means of the plastic fixing clip (≥ DN 50 / ≥ G 2). See diagrams for installation position and depth.

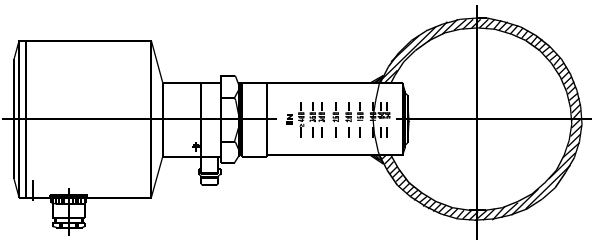

Weld on the nozzle at the marking according to its nominal width, free of distortion.

Run-in and run-out sections must be greater than or equal to 10 x pipework diameter. Weld on the connection sleeve at right angles to pipework mid-line (see marking = external pipework diameter, for >DN 400 also at 400). Avoid distortions. The probe must screw in easily. After screwing in, the probe can be adjusted by rotating it.

The complete measurement probe is removable without creating an opening to the medium, and so if a fault occurs, only the electronic part is replaced.

The electrical connection is made after opening the cover (unlosable because of its earthing cable). For this, completely remove the three internal hex bolts from the lid. (Take care not to lose them)

The arrow on the electronics insert must be in the direction of flow (loosen bolts 4 and 5 by approx. 2 or 3 turns. Do not remove completely!) Turn the electronic component appropriately, and then tighten the bolts again. The alignment of the arrow has nothing to do with the alignment of the housing. This is possible at any time, without affecting the alignment of the internal component.

The metering range full scale value has already been set in the factory to the desired metering range, by means of the DIP switches (1, 2, 3, 4, 5, 6, 7, 8 m/s, see drawing). The figures next to the DIP switches are valid.

Ordering code

FIS 1. 2. 3. 4. 5.

○=Option

1. Nominal width		
025	DN 25 (welded-on nozzle)	
050	DN 50 (tapping sleeve)	
065	DN 65 (tapping sleeve)	
080	DN 80 (tapping sleeve)	
100	DN 100 (tapping sleeve)	
125	DN 125 (tapping sleeve)	
150	DN 150 (tapping sleeve)	
2. Process connection		
V	welded-on nozzle	●
B	tapping sleeve	●
3. Material for mechanical connection		
K	stainless steel (welded-on nozzle)	●
B	PP (tapping sleeve)	●
4. Full scale value of range		
001	1 m/s	
002	2 m/s	
003	3 m/s	
004	4 m/s	
005	5 m/s	
006	6 m/s	
007	7 m/s	
008	8 m/s	
5. Electrical connection		
G	cable screw gland Pg 9 excluding cable	
S	○ for round plug connector M12x1, 4-pole	

Accessories

- Cable/round plug connector (KB...) see additional information "Accessories"